

PUNCHED CABLE ENTRY PLATES WC - FL

CHARACTERISTICS

Manufactured from 1.5 mm thick sheet steel.

PAINT FINISH

ETA standard epoxy polyester powder coating.
Colour: RAL 7035 textured finish.

SUPPLY

Includes 1 piece with gasket, screws for FL frame and mounting accessories.



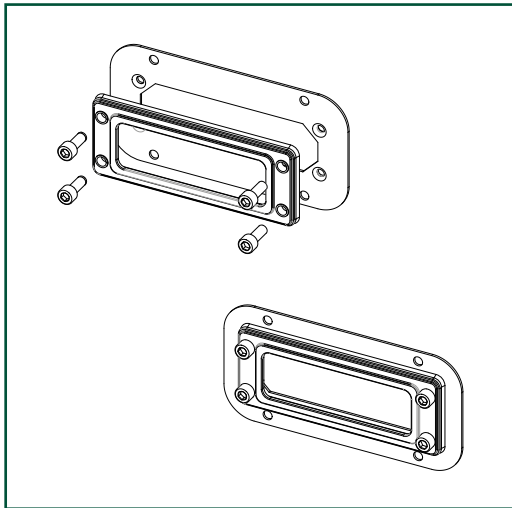



Note: it is available the package with 5 pieces, complete with gaskets, screws for the FL frame and mounting accessories; in this case add suffix "5" to the code (i.e.: WC016FL5).



PUNCHED CABLE ENTRY PLATES

WC CODE	PLATE DIM.	NO. OF HOLES	HOLE DIM.
WC016FL	158 x 78	1 per FL13	118 x 30
WC018FL	258 x 78	1 per FL13	118 x 30
WC019FL	258 x 128	1 per FL21	196 x 62
WC020FL	358 x 128	1 per FL21	196 x 62
WC022FL	558 x 128	2 per FL21	196 x 62

COMBINATIONS

FL13	3x 	3 small squared inserts
	1x  + 1x 	1 small squared insert + 1 horizontal rectangular insert
FL21	2x  + 1x 	2 big squared inserts + 1 vertical rectangular insert
	5x 	5 vertical rectangular inserts
	10x 	10 small squared inserts



FL13 AND FL21 FRAMES

CHARACTERISTICS

In reinforced fiberglass, polypropylene and thermo-plastic halogen-free elastomers. UL approved materials.

Colour: RAL 7035.

PROTECTION RATING

IP65.

TEMPERATURE RESISTANCE

-20°C +125°C.

TEST

EN62262
EN60670-1, EN50262.

SUPPLY

Includes 10 pieces.

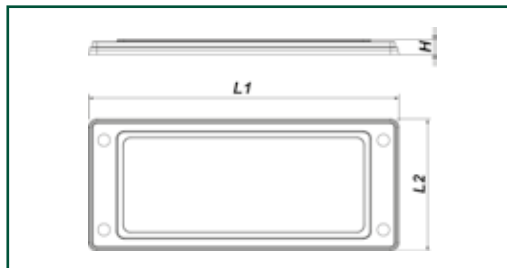

FRAMES

CODE	DESCRIPTION	L1	L2	H
WC2665404	FL13 FRAME	134	52	6,5
WC2665400	FL21 FRAME	214	90	9

Boxes