

	6 037 70	6 037 71
	230V 50/60Hz	230V 50/60Hz
	1x 16A/250V~μ cos φ = 1	2x 16A/250V~μ cos φ = 1
Power consumption	0,9 W	1,3 W
Programs:	28	14 / channel
Ganggenauigkeit	± 1 s / day under typical installation conditions	
	1 ... 4 mm ²	0,5 ... 2,5 mm ²
Battery reserve:	3 years	
	- 20 °C ... +55 °C	
	- 20 °C ... +60 °C	

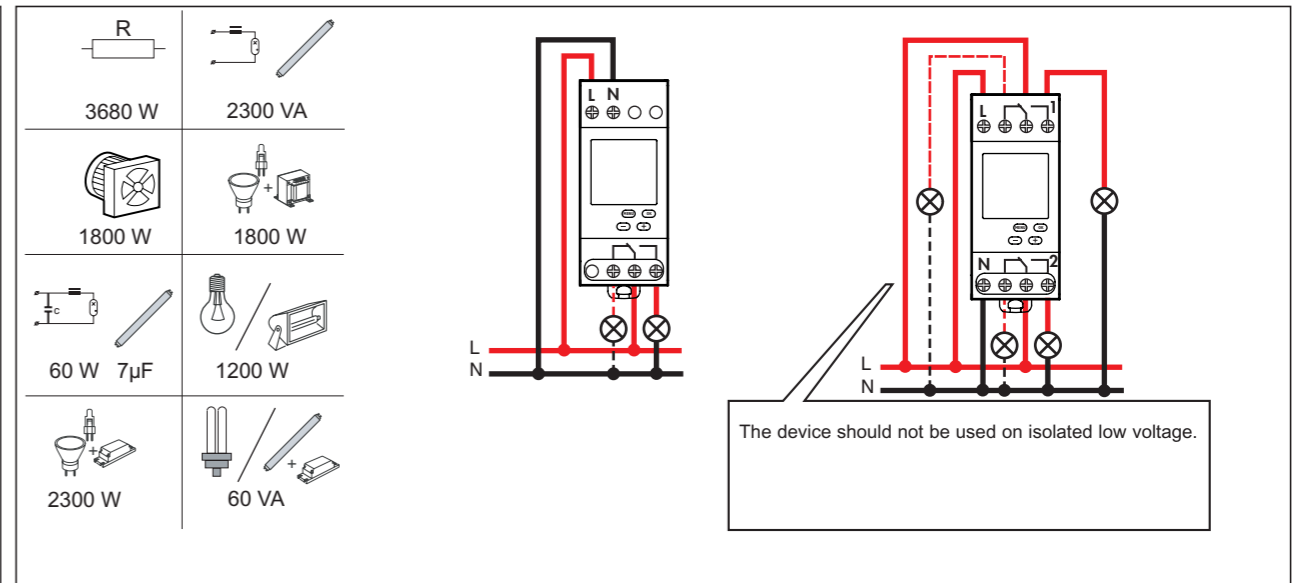

⚠ Safety notes

This product may be installed only by a qualified electrician. Non-compliance may result in a fire hazard or electric shocks. Before installation, read the operating instructions and observe the product-specific requirements for the installation location. Use only original spare parts for repair and maintenance. All Legrand products may be opened and repaired only by specially trained Legrand personnel. Unauthorised opening and repair by other persons will invalidate all claims for liability, replacement or warranty services. The device contains a Li cell type battery (Li) CR2032. When the product reaches the end of its life, this cell must be correctly removed and disposed of in accordance with national legislation and the requirements of environmental protection.

Operating principle:
Typ 1.B. S. T.
IEC/EN 60730-1,
IEC/EN 60730-2-7
Operation in a normal environment
Montage: in distribution panel,
Degree of contamination: 2
Switch output, potential-free

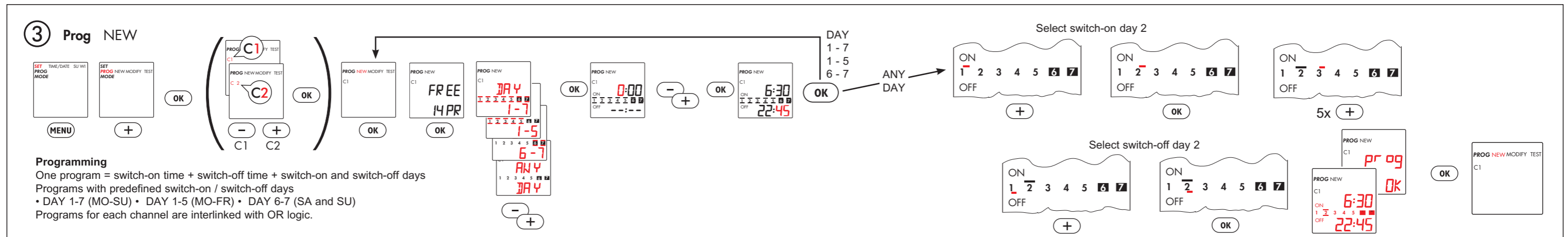
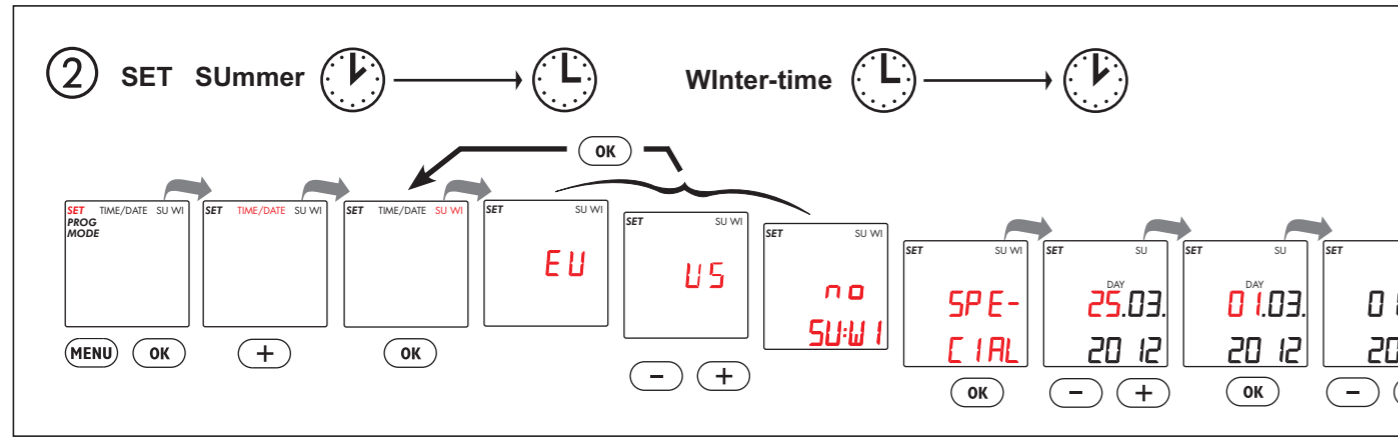
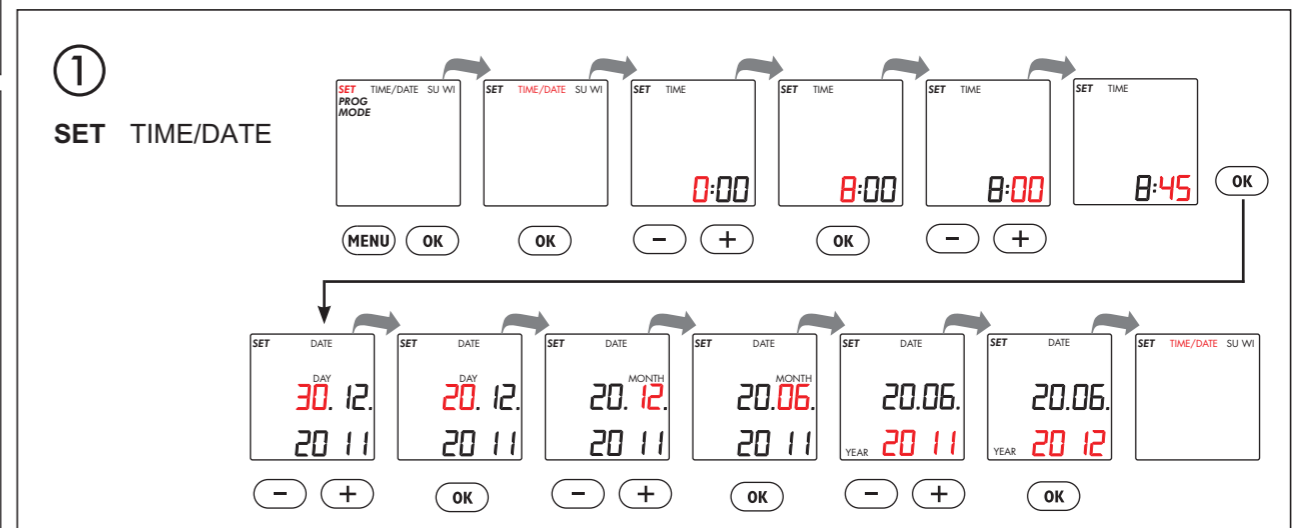

4 Prog MODIFY

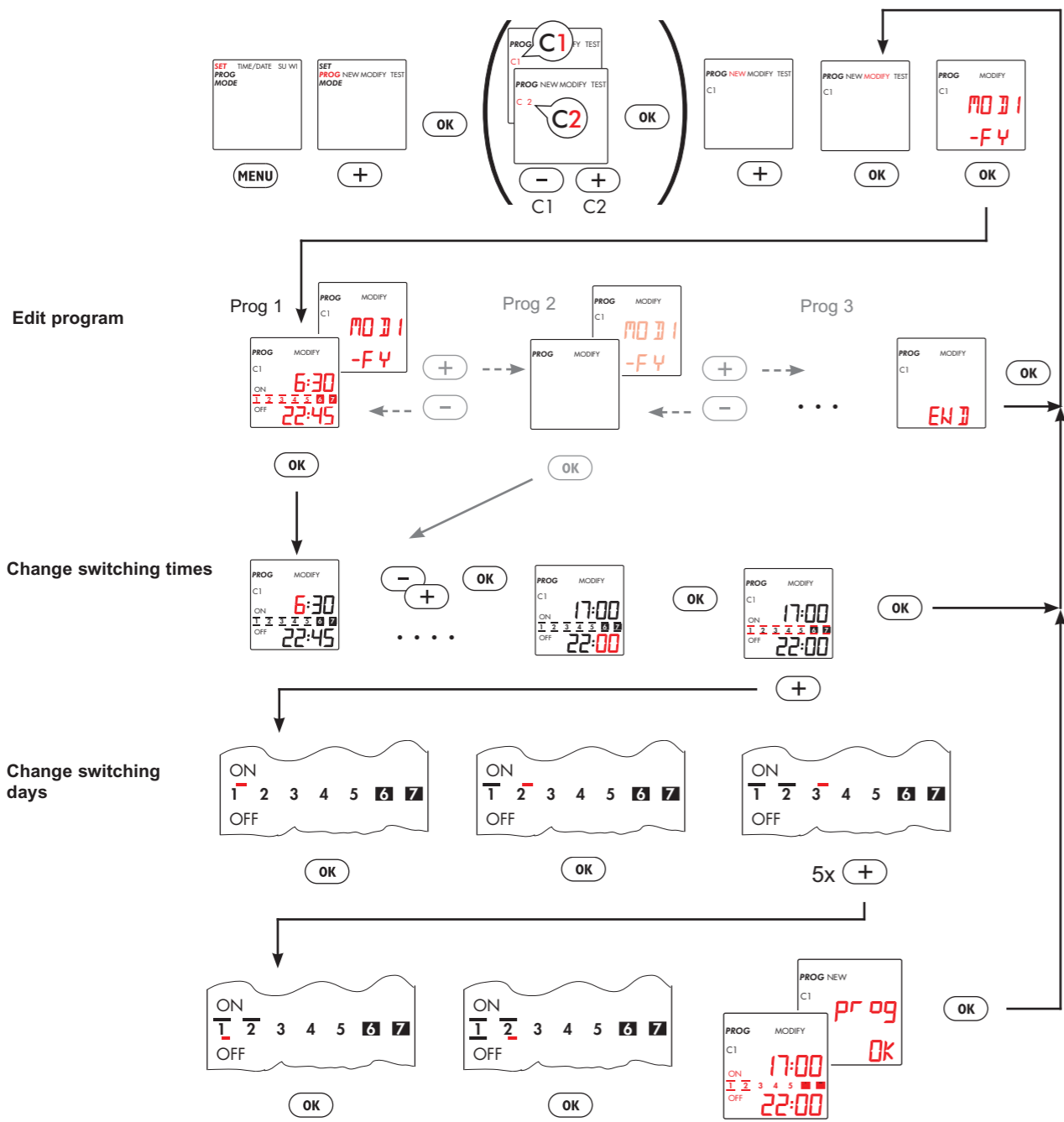

4A Prog MODIFY

DEL ONE -> Delete a single program,

DEL C1/2 -> Delete the programs for a channel

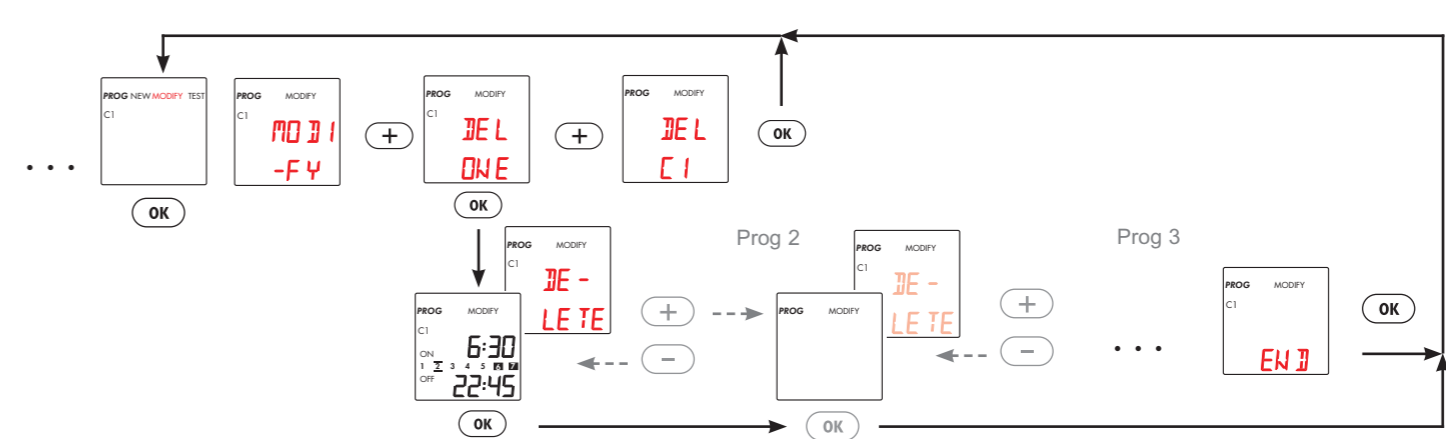

5 Prog TEST

prog -> Programs in the order entered

SERIAL -> Switching commands in chronological order

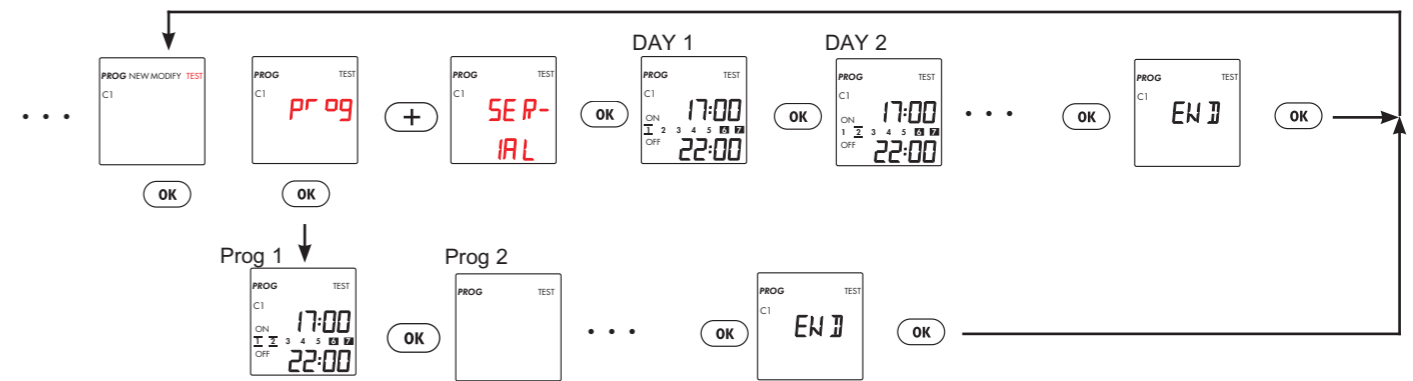

6 Mode PERMANent

Continuous switching On/Off

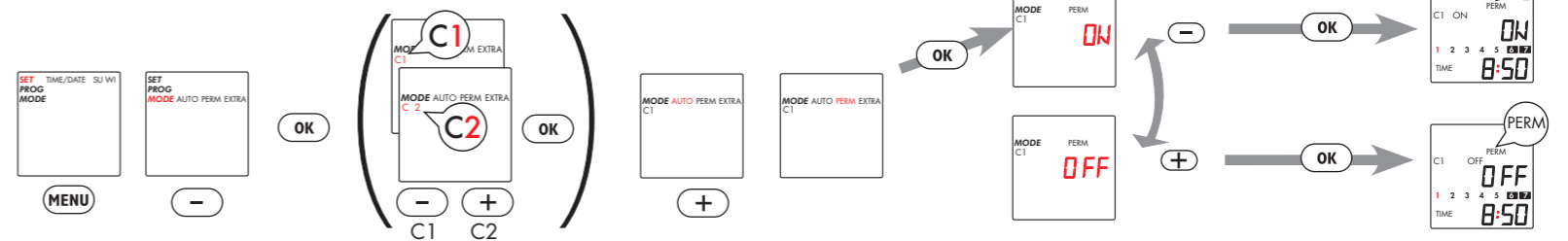

7 Mode EXTRA

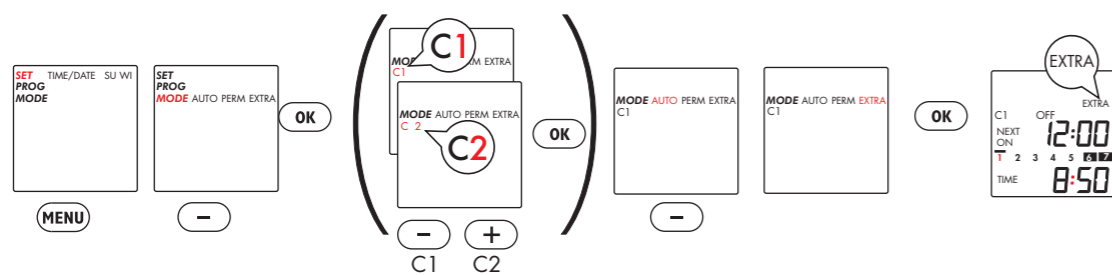

State of contact set by program will be reversed. The next program automatically returns the switch to ON or OFF as programmed.

Reset



Note!

A reset clears the entire memory, which means that all previously set data will be lost. Press and hold all four keys together for about 2 seconds, then release them. The time, date, summertime/wintertime and switching times will have to be re-entered.

Switch off the device before dismantling the module. Do not switch on again until the module has been installed. Always use a Li cell type battery (Li) CR2032, 3V. High temperature type min +70°C.

